

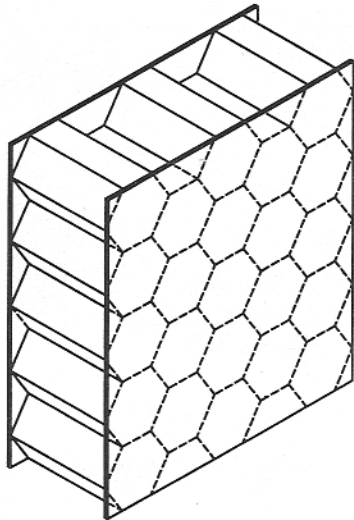

D1-1

1-3/4" REGENT (RI) HONEYCOMB CORE DOORS

FLUSH AND EMBOSSED PANEL STEEL DOORS
BEVELED LOCK EDGE, HANDED



Chemically treated, 99 lb. test, one inch cell, kraft fibre honeycomb slab, bonded to the inside of both face sheets with a waterproof, contact adhesive. Crush Strength: 45 psi.

Suggested Use:

- Interior or Exterior ...*
- Office*
- Motel/Hotel*
- Apartment*
- Urban Renewal*
- Health Care*
- Institutional*
- Mercantile*
- Public Utility*
- Factory*
- Warehouse*

DOOR DESIGNS

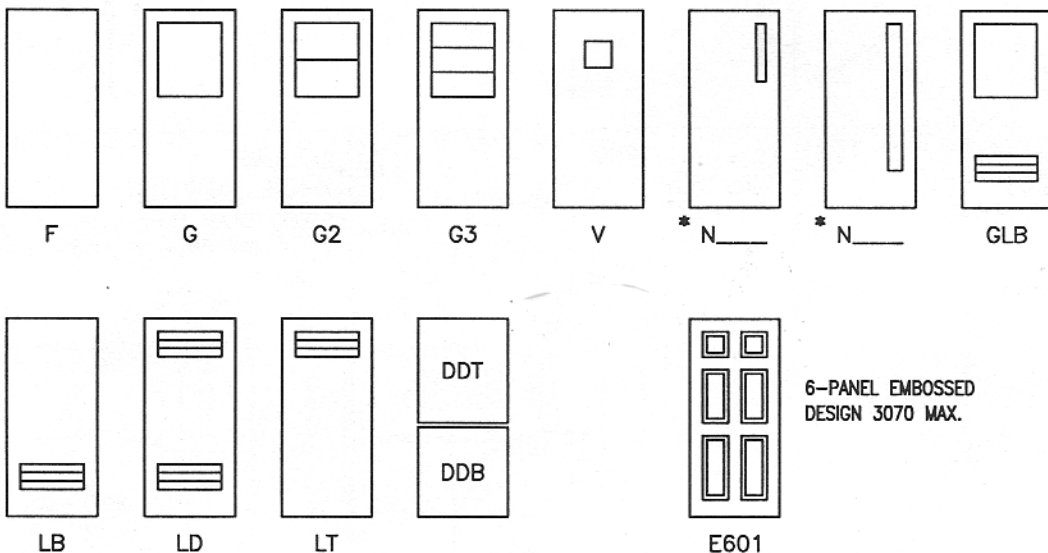

* NARROW LITE TRIM KITS ARE AVAILABLE IN 6" AND 8" WIDTHS AND 36" TO 60" HEIGHTS IN 4" INCREMENTS.

6-PANEL EMBOSSED DESIGN 3070 MAX.

6/1/01

D1-2

Hardware locations shown match Ceco standard frames.

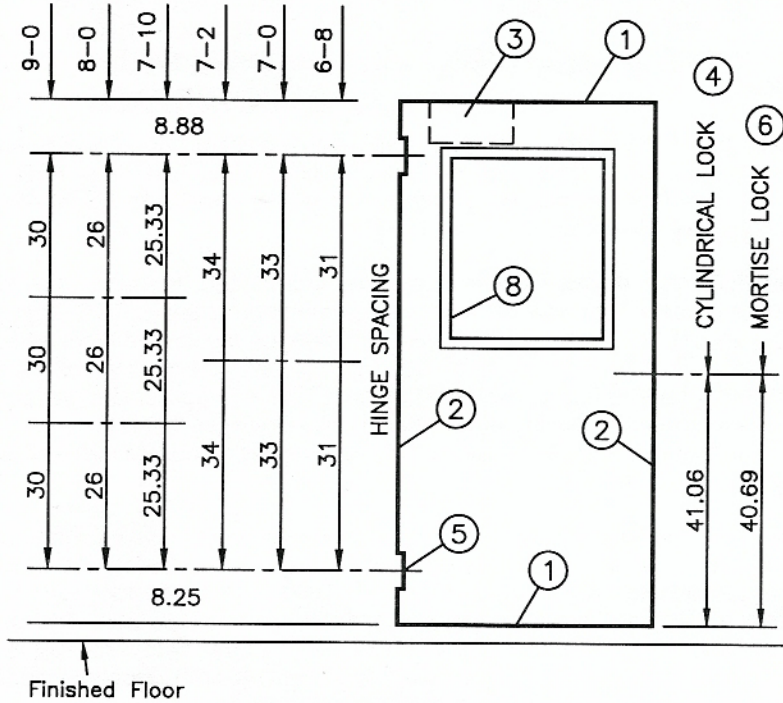

DOOR ELEVATION

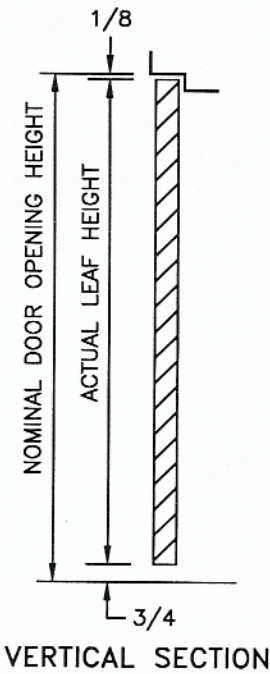

VERTICAL SECTION

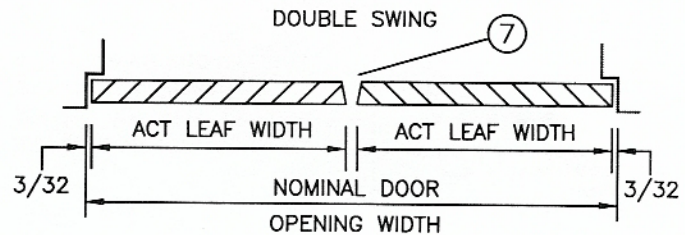
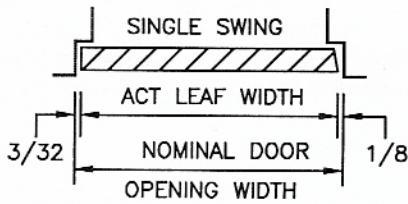

HORIZONTAL SECTIONS

(Conversion: 1" = 25.4 mm, e.g., 1-3/4" = 44.45 mm)

⑦ OVERLAPPING ASTRAGAL 4451
FOR 1-3/4" THICK DOORS WITH OPTIONAL POLY-PILE INSERT

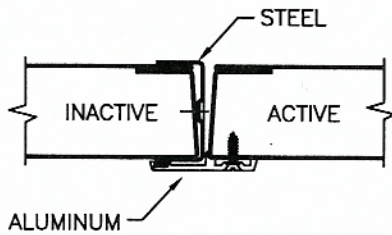

⑦ OVERLAPPING ASTRAGAL 4441
FOR 1-3/4" THICK DOORS

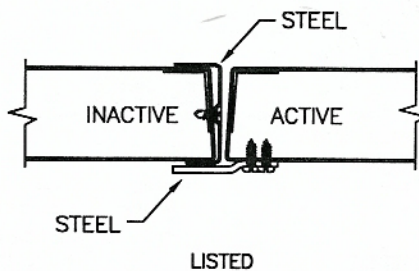

⑦ OVERLAPPING ASTRAGAL 4471
FOR 1-3/4" THICK DOORS

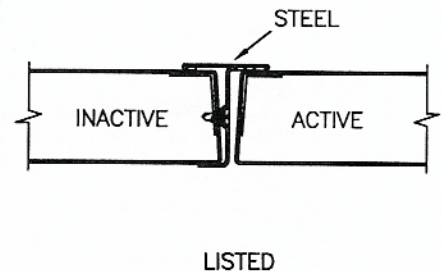

6/1/01



Ceco Door Products

TECH-DATA

REGENT DOORS

16 GAGE STEEL
END CHANNELS

WELDED
TO DOOR

FLUSH
TOP AND
BOTTOM
CHANNELS

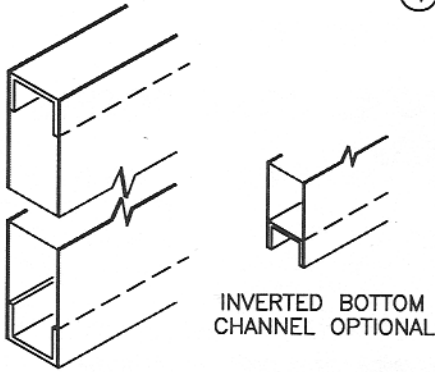

INVERTED BOTTOM
CHANNEL OPTIONAL

① VERTICAL EDGES

MECHANICALLY
INTERLOCKED
HEMMED EDGES

ALSO AVAILABLE
SEAMLESS (WELDED
OR BODY FILLER)

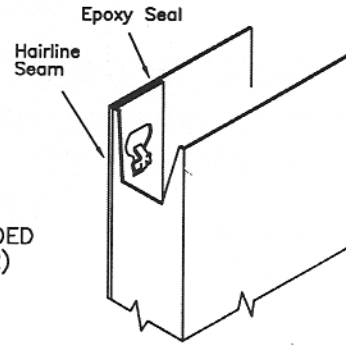

②

CLOSER
REINFORCEMENT
(OPTIONAL)

12 GAGE STEEL
CHANNEL 16" LONG

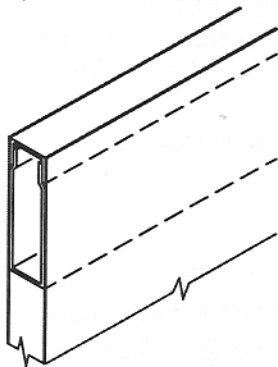

③ LOCK PREPARATION
GOV. 160/161
CYLINDRICAL TYPE

(LC1)

(ANSI A115.2)
2-3/4"
BACKSET

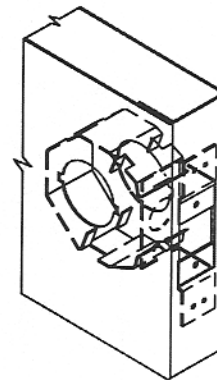

④

HINGE
PREPARATION

4-1/2 OR 5 IN.
HIGH, STANDARD
OR HEAVY WEIGHT,
FULL MORTISE
HINGES

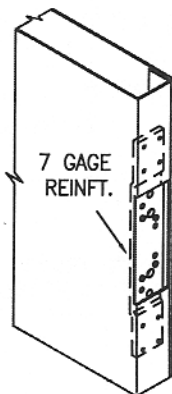

7 GAGE
REINFT.

ANSI A156.7
TEMPLATE

HINGE EDGE IS HANDED
AND NOT BEVELED.

⑤ LOCK
PREPARATION
GOV. 86-4
MORTISE TYPE

(LM1) (ANSI A115.1)
2-3/4" BACKSET

(LMO) SIMILAR TO DETAIL
LESS FACE CUTOUT

(LPO) SIMILAR TO DETAIL
LESS ALL CUTOUTS
AND REINFORCEMENT

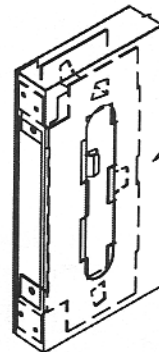

LOCK EDGE IS BEVELED
1/8" IN 2" (1:16)

⑥

GLAZING TRIM
4831 (APPLIED)

FOR STANDARD
FLUSH DOORS

ALUMINUM

3/8" WIDE
GLAZING
POCKET

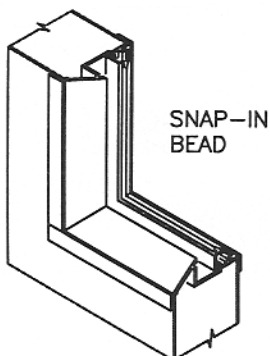

SNAP-IN
BEAD

⑧ GLAZING TRIM
SlimTrim

FOR ALL
FIRE DOORS

STEEL

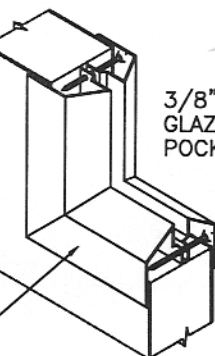

3/8" WIDE
GLAZING
POCKET

LISTED

⑧ LOUVER
4634 (APPLIED)

FIXED SLAT TYPE
FREE AIR AREA APPROX. 43%

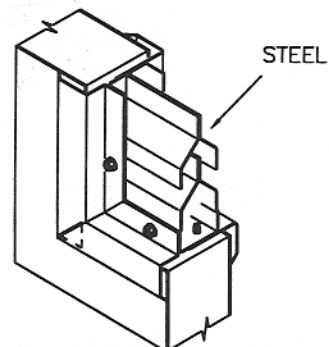

STEEL

⑨



Ceco Door Products

6/1/01

PRODUCT SPECIFICATIONS:

1-3/4" Thick steel doors shall be as manufactured by Ceco Door Products, Milan, TN USA. Doors shall conform to the Steel Door Institute guide specification, ANSI A250.8-1998; see chart below for performance classifications.

STANDARD SIZES NOMINAL DOOR OPENING

WIDTH		HEIGHT
SINGLE	DOUBLE	
2'-0"	4'-0"	6'-8"
2'-4"	4'-8"	
2'-6"	5'-0"	7'-0"
2'-8"	5'-4"	7'-2"
2'-10"	5'-8"	7'-10"
3'-0"	6'-0"	8'-0"
3'-4"	6'-8"	9'-0"
3'-6"	7'-0"	
3'-8"	7'-4"	
3'-10"	7'-8"	
4'-0"	8'-0"	

REGENT doors are made full-flush or (optional) seamless style. Face sheets are commercial quality cold rolled steel conforming to ASTM A366 or A620 & A568 ...or (optional) hot-dipped galvanized steel conforming to ASTM A924 and A653 -- see chart below.

Regent full-flush doors have mechanically interlocked, hemmed, hairline seams on vertical edges and have no visible seams on faces (S.D.I Design I). Doors specified "seamless" have no visible seams on faces or vertical edges (S.D.I. Model II). A one piece, chemically-treated, 99 lb., one inch cell, kraft-fibre honeycomb slab is securely bonded to both face sheets under pressure with contact adhesive. The top and bottom door edges are closed flush by 16 gage steel channels welded in place. The bottom edge channel can also be installed inverted (optional).

FIRE DOORS

LABELING AGENCIES:

- UNDERWRITERS LABORATORY
- WARNOCK HERSEY
- FACTORY MUTUAL

TEST: ASTM E-152, UL10B, UBC 43-2

- RATING: 20 MIN, 3/4 HR, 1-1/2 HR, OR 3 HR
- MAX. SIZE: 40 x 90 SINGLE
80 x 90 PAIR
- DESIGNS: F, G, N, & V

Not all ratings are available in all sizes, designs and materials.

Hardware Provisions: Hinge preparations are handed. Hinge edges are mortised for 4-1/2" or 5" high, standard and heavy weight hinges (specify which). 7 gage steel hinge reinforcements are welded inside the door edge and are drilled and tapped for fasteners in accordance with ANSI A156.7. The lock edge has a standard bevel (1:16) and is prepared for Gov. series 86, 160/161, or 90 locks in accordance with ANSI A115 (specify which). Optional closer reinforcement is a 12 gage steel channel.

Paint: 1-3/4" steel doors shall be provided with one coat of oven-cured neutral color primer paint. Primer coat shall conform with ANSI A250.10. The primer coat is a preparatory base for necessary finish painting. "Colorstyle" finish coat is also available from a selection of standard colors (optional). Colorstyle finish is electrostatically applied, oven-cured urethane enamel. For accurate color selectors ask for a Ceco Colorstyle chart.

MATERIAL

DOOR FACE SHEETS	GRADE	C.R.	GALV			RECOMMENDED DOOR FRAME MATERIAL
			A40	A60	G90	
20 Gage Steel (4080 max.)	Standard Duty	STD	-	OPT	-	16 Gage Steel
20 Gage Textured Steel (4080 max.)	Standard Duty	-	STD	-	-	16 Gage Steel
18 Gage Steel	Heavy Duty	STD	-	OPT	OPT	16 Gage Steel
16 Gage Steel	Extra heavy Duty	STD	-	OPT	OPT	16 or 14 Gage Steel

PERFORMANCE

Core Thermal Characteristics:	U Factor: 0.41 R Factor: 2.44
Sound Transmission Class:	STC 32 (F Design, 18 Gage Face Sheets, ASTM E90-81 & E413-73 [Fully Operable])
Physical Endurance /Level:	Meets ANSI A 151.1 Performance Test, 20 GAGE: Level B (500,000 Cycles); 18 and 16 Gage: Level A (1,000,000 Cycles)



Ceco Door Products