

PREFINISHED DOOR FRAMES

STEEL

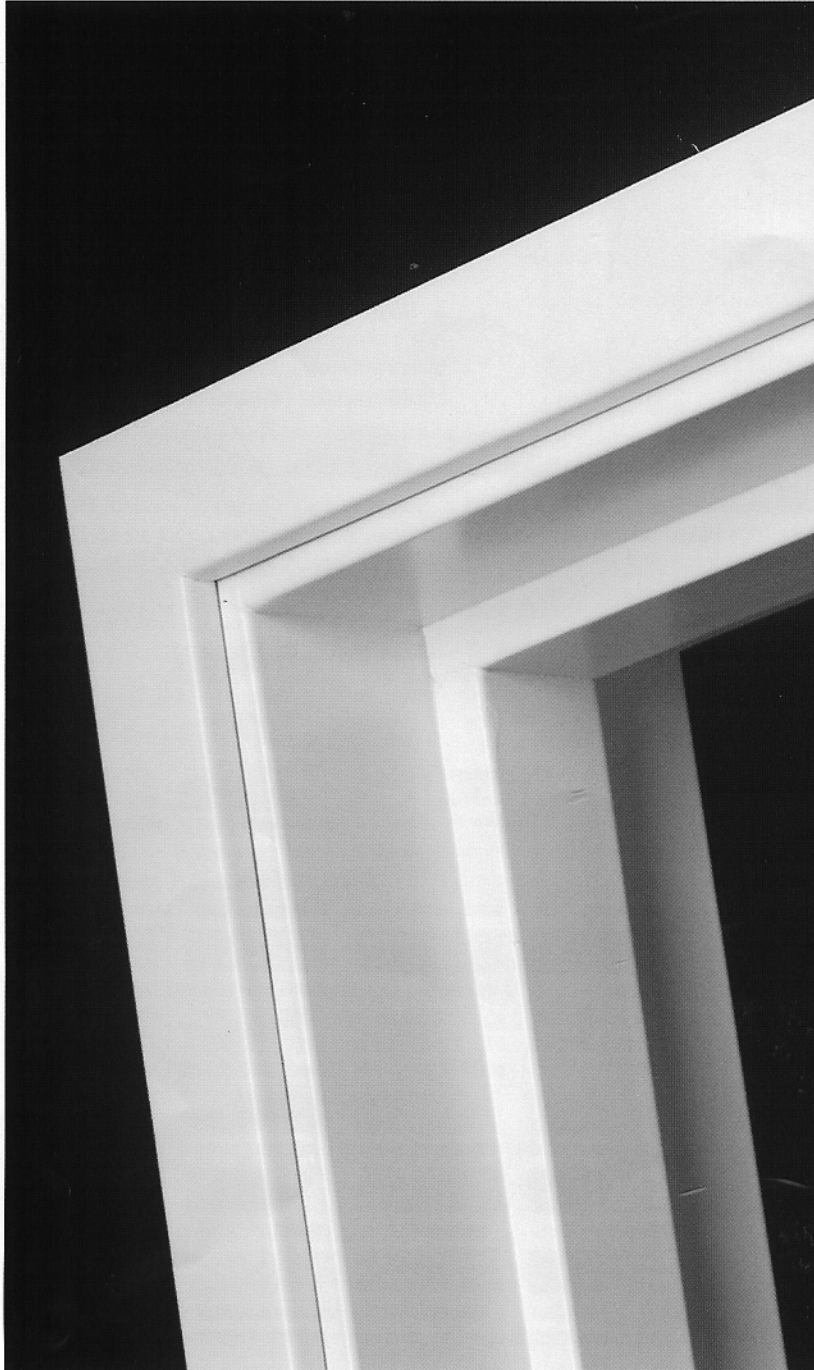

INCOMPARABLE STEEL DOOR FRAME SYSTEMS FROM THE LEADER

- **Quality.** Assured by Timely's 30 plus trendsetting years in the field.
- **Versatility.** 5 casing design options, 6 stocking and 29 custom colors.
- **Safety.** Full 90-minute fire rating available.
- **Strength & Beauty.** Sturdy full perimeter anchoring, plus matching borrowed lites and sidelites.



POSITIVE
PRESSURE
APPROVED

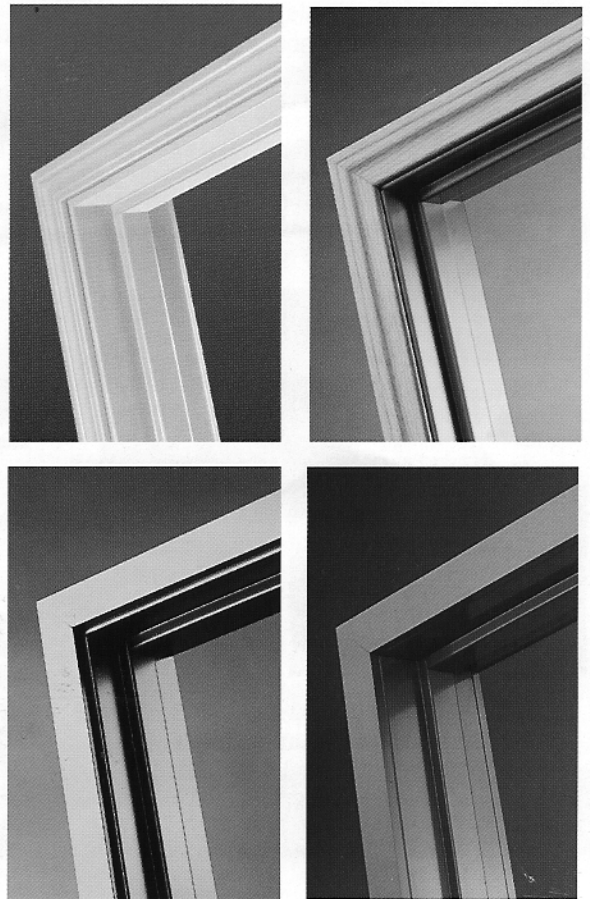





TIMELY®

PREFINISHED STEEL DOOR FRAMES

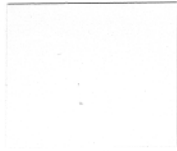









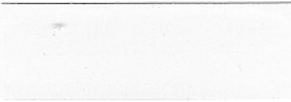
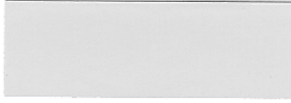



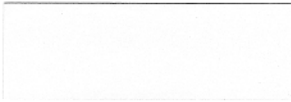
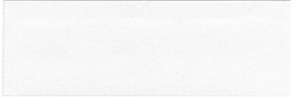
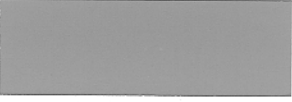
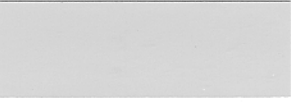
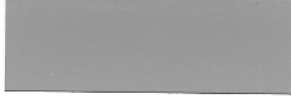
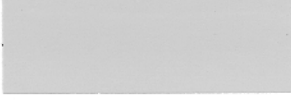

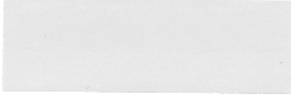

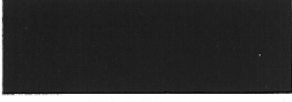

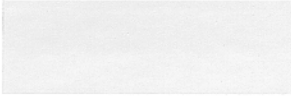
A DIVISION OF S.D.S. INDUSTRIES, INC.

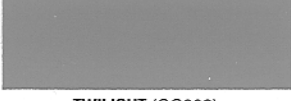
Timely Finishes **Available for adjustable frames in powder coat.*

STANDARD PRICE		ADD 26¢ Per Foot			
					
BROWNTONE (SC101)*	WESTERN WHITE (SC107)*	AUTUMN BROWN (SC102)	BLACK (SC103)*	STONE GRAY (SC106)	ALUMATONE (SC108)

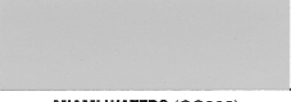
Pre-Matched Custom Finishes

*Custom color matching also available.
 Submit color chip. Consult factory for pricing.*

			
WHITE WHITE (CC301)	WHITE SMOKE (CC302)	NAVAJO WHITE (CC104)	WINTER WHITE (CC105)
			
CHARCOAL (CC401)	CAPE COD GRAY (CC402)	BONE CHINA (CC303)	DESIGNER WHITE (CC304)
			
DRIFTWOOD (CC501)	SANDY BEACH (CC502)	NEUTRAL GRAY (CC403)	NICKEL (CC404)
			
BROWN SUGAR (CC601)	COCOA (CC602)	CAMEO BEIGE (CC503)	COZY PEACH (CC504)
			
CORDOVAN (CC701)	RUBY RED (CC702)	DOESKIN (CC603)	HARVEST MOON (CC604)
			
PACIFIC BLUE (CC801)	TWILIGHT (CC802)	ROSEDUST (CC703)	MAUVE MIST (CC704)
			
KENTUCKY GRASS (CC902)	MIAMI WATERS (CC903)	COUNTRY BLUE (CC803)	JADE (CC901)
			
		MALIBU GREEN (CC904)	

Elite Series

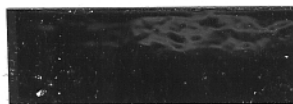

BRIGHT SOLID BRASS (ES201)
 BRIGHT PLATED BRASS (ES202)

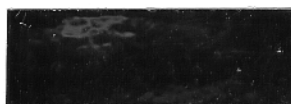

STAINLESS STEEL
 430 BRIGHT (ES204)



304 #4 BRUSHED STAINLESS
 STEEL (ES206)

For complete technical information, contact your Timely distributor or our Marketing Service Department. Colors shown may vary slightly. Colors & price subject to change. Color chips available upon request, all finishes are semi-gloss unless otherwise specified. Touch-up paint available upon request, colors may vary slightly.

Frame Profiles for 1-3/8" Doors

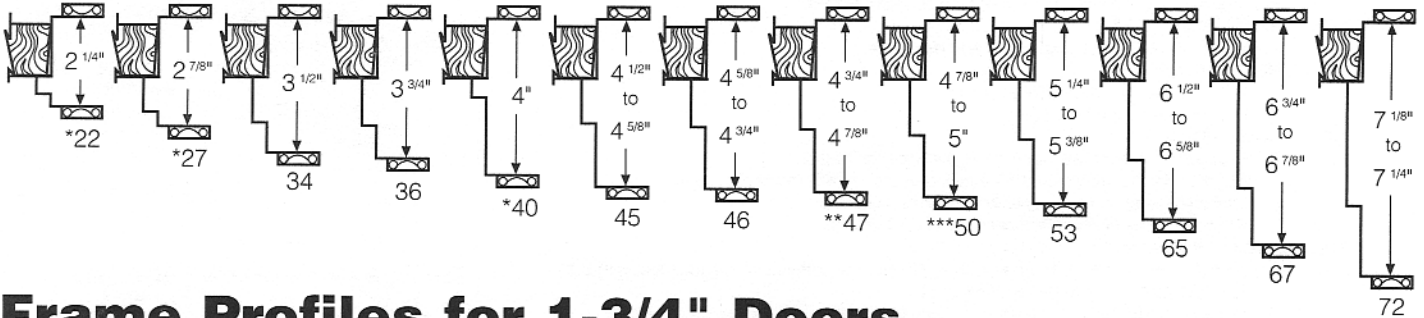

Frame Profiles for 1-3/4" Doors

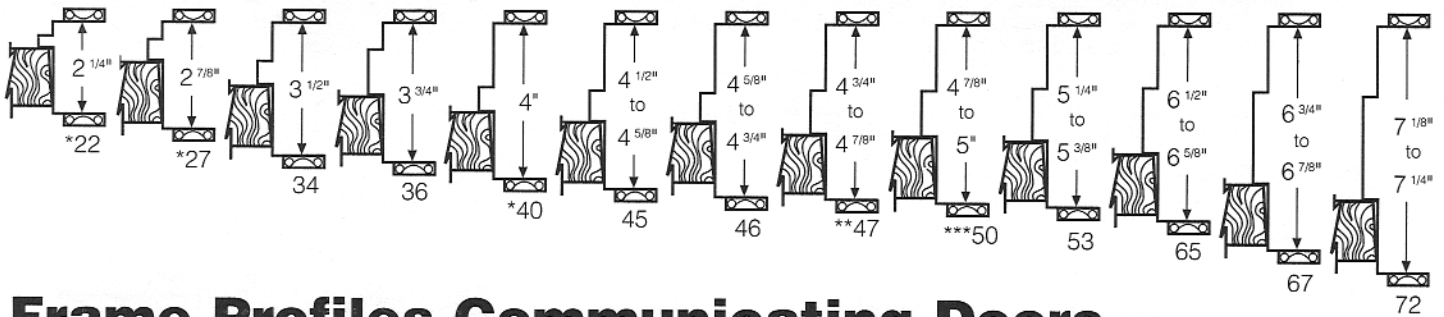

Frame Profiles Communicating Doors

Maximum reduction of noise level traveling from room to room through communicating doors is best achieved by using different door thicknesses. Our standard communicating frame is designed to utilize a 1 3/8" and a 1 3/4" door.

Also available to accommodate two 1 3/4" or 1 3/8" doors upon request.

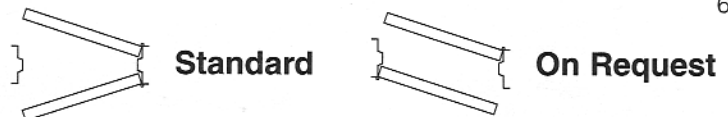
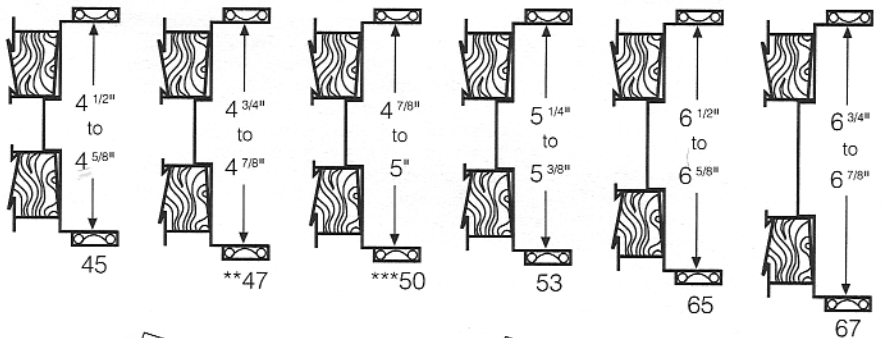

- * Denotes special order. Refer to office
- ** Recommended for use with 3 1/2" wood studs
- *** Recommended for use with 3 5/8" steel studs

Adjustable Frame Profile for 1-3/4" Doors

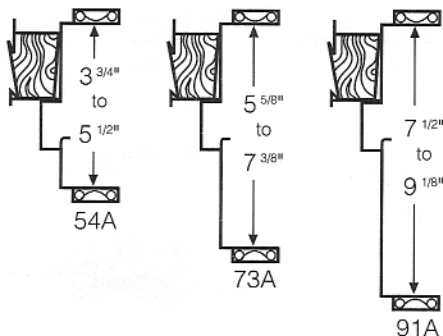

Non-Standard Wall Sizes

Timely-Prefinished Steel Door Frames are readily available for non-standard wall sizes up to 13" in width and 10 feet in length. Wall sizes less than 4 1/2" and communicators with equal rabbets are limited to 10' in length. Please contact Timely for additional information and availability of sizes.

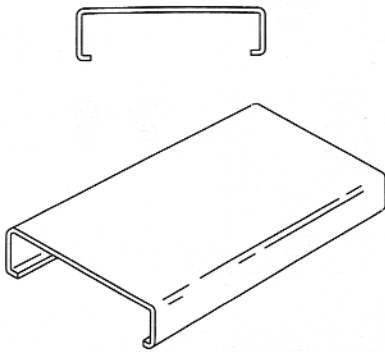

TA-8 Steel Casing
 (1 7/16" Profile) Finishes: Navajo White, Browntone, Black, Autumn Brown, Stone Gray, Western White, Winter White and all Elite Finishes.
 See page T-1

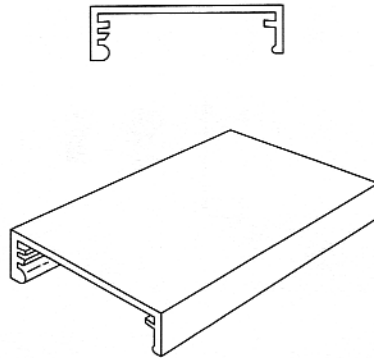

TA-23 Aluminum Casing
 (1 17/32" Profile) Finishes: Browntone, Black, Clear Anodized, Alodine.
 (Consult factory for additional finishes)
 See page T-1

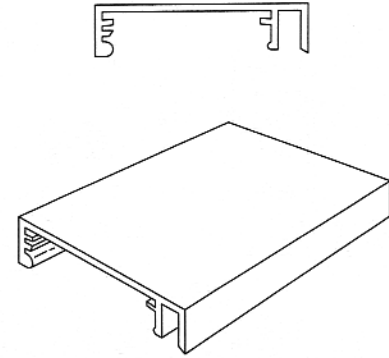

TA-28 Aluminum Casing
 (1 25/32" Profile) Finishes: Browntone, Black, Alodine.
 (Consult factory for additional finishes)
 Only available with 4 1/2" hinge emboss
 See page T-2

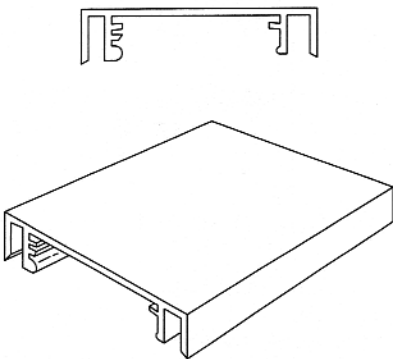

TA-28M Aluminum Mullion Casing
 (2" Profile) Finishes: Browntone, Black, Alodine.
 (Consult factory for additional finishes)
 See page T-2

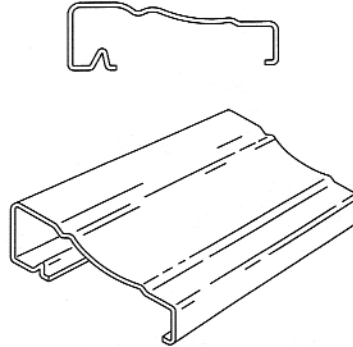

TA-30 Colonial Steel Casing
 (1 3/4" Profile) Finishes: Browntone, Black, Navajo White, Autumn Brown, Stone Gray, Western White, Winter White.
 Not Available on Mullions or Sill
 See page T-3

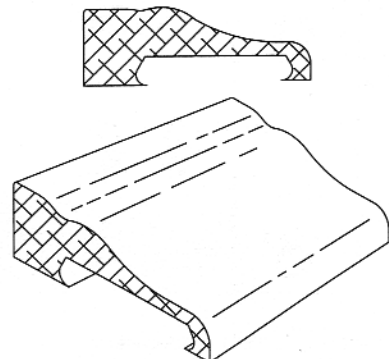

TA-35 Colonial PVC Casing
 (1 15/16" Profile) Finishes: Navajo White, Browntone, Black, Western White, Autumn Brown, Stone Gray, Winter White.
 (Consult factory for availability)
 Not Available on Mullions or Sill
 See page T-3

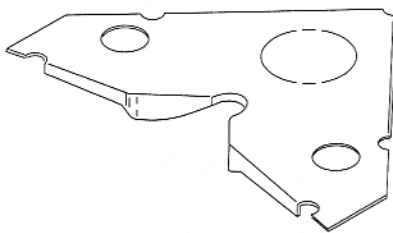

TA-6 Casing Corner Piece
 Finishes: Navajo White, Browntone, Black, Western White, Autumn Brown, Stone Gray, Winter White. Used to ensure tight miters.
 (used with TA-8)
 See page T-1

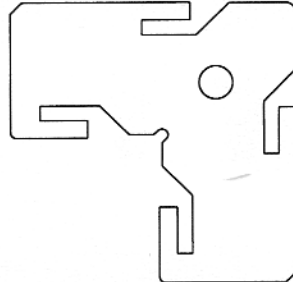

TA-24 Aluminum Casing Corner Piece
 Finishes: Browntone, Black.
 Used to ensure tight miters.
 (used with TA-23, TA-28)
 See page T-1

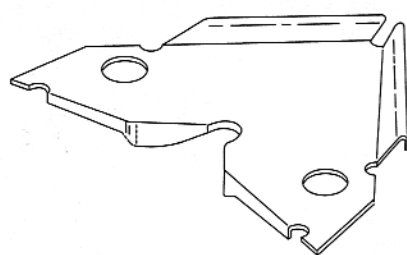

TA-31 Casing Corner Piece
 Finishes: Navajo White, Browntone, Black, Western White, Autumn Brown, Stone Gray, Winter White.
 Used to ensure tight miters. (used with TA-30)
 See page T-3

SINGLE SWING FRAMES

	Maximum Opening Size		Wall Size		Frame Series
	Width	Height	Min.	Max.	
20 Min. 'C' Label	4/0	10/0	3 3/8"	13"	C
45 Min. 'C' Label	4/0	9/0	3 3/8"	13"	S, C, M, A, E**
90 Min. 'B' Label	4/0	9/0	3 3/8"	13"	S, C, M, A, E**

** 304 series and solid brass not rated

FULL BOUND WITH DOOR

	Maximum Opening Size		Wall Size		Frame Series
	Width	Height	Min.	Max.	
45 Min. 'C' Label	4/0	5/0	3 3/4"	13"	S, C, E**
90 Min. 'B' Label	4/0	5/0	3 3/4"	13"	C

** 304 series and solid brass not rated

SIDELITE, BORROWED LITE AND GLAZED TRANSOMS 45 MINUTES AND 60 MINUTES RATING.

Rating not available in sidelites or borrowed lites with wood trim.

Glass Stop Size	Rating	Max Assembly Size 10'1" W x 10'1" H		Wall Size		Max Glass Area
		Width	Height	Min.	Max.	
1/2	45 Min.	24"	107"	3 3/8"	13"	*2568 Sq. In.
**1/2	45 Min.	36"	54"	3 3/8"	13"	1296 Sq. In.
No Stop						
3/4	45 Min.	36"	54"	3 3/8"	13"	1296 Sq. In.
Glass Stop Size	Rating	Max Assembly Size		Wall Size		Max Glass Area
		Mullions Not Permitted		Min.	Max.	
		Width	Height			
***1/2	60 Min.	36"	36"	3 3/8"	13"	1296 Sq. In.

Non-Mullions can be in "S" or "C" gauge. Mullions are always "C" gauge

Do not exceed maximum assembly size.

*Most building codes limit glass area to 1,296 sq. in. Do not exceed 1,296 sq. in. without verifying with local code authorities prior to specifying or ordering.

**Must be caulked using 100% Pure Silicone Sealant.

***Must use Firelite glazing and install in a 5/8" wide glazing recess with 100% Pure Silicone Sealant.

WARNOCK HERSEY INC. LABELING SERVICE

Distributors of Timely Frames may be approved to purchase labels and apply them to frames at their own facility. Warnock Hersey has set guidelines and a fee schedule for this program. Requirements and prices are available from Timely or Warnock Hersey Inc.

PAIR FRAMES

	Maximum Opening Size		Wall Size		Frame Series
	Width	Height	Min.	Max.	
20 Min.	For 20 Min. Pair, use C Label Requirements.				
45 Min. 'C' Label	8/0	9/0†	3 3/8"	13"	S, M, C, E**
90 Min. 'B' Label	8/0	9/0†	3 3/8"	13"	S, M*, C, E**

* M series (6-0 x 8-0) ** 304 series and solid brass not rated

NOTES: † Openings over 6/0 wide to 8/0 wide are limited to 8/0 height.

ADJUSTABLE FRAMES

	Maximum Opening Size		Wall Size		Frame Series
	Width	Height	Min.	Max.	
45 Min. 'C' Label	6/0	8/0	3 3/4"	9 1/8"	A
90 Min. 'B' Label	6/0	8/0	3 3/4"	9 1/8"	A

GENERAL INFORMATION

All ratings are usable for steel stud, wood stud, or masonry construction (Steel sub-buck).

When using a wood sub-buck in place of Timely's metal insert for masonry construction, drywall must be used on both sides.

Wood or aluminum casing does not affect ratings on door frames.

Single frames not prepared for strikes must use TA-12 rim panic strike reinforcement.

Fire ratings not approved for deadbolt strike only.

Reinforcements are required when using door closers to maintain fire rating.

Fire ratings not approved for 1 3/8" frames.

TIMELY INDUSTRIES LIMITED WARRANTY

S.D.S. Industries, Inc., a California Corporation D.B.A. Timely Industries (hereafter called Timely) warrants to the original consumer purchaser that its Timely Prefinished Steel Door Frame, when utilized for interior frame use, will be free from defects in material and workmanship for a period of one year from the date of purchase.

This warranty is applicable only when the products covered by it:

- 1) have been installed in accordance with the recommended written installation instructions of Timely Industries and with established building practices.
- 2) have been accorded treatment which is considered good practice in the Building Industry regarding storage and maintenance.
- 3) have been subjected only to normal use because Timely Industries cannot control the manner in which its products are handled after leaving its premises.
- 4) this warranty does not apply to the finish or accessories of any product, and shall not apply to any frame exposed to a corrosive or humid environment. If the frames are used for exterior exposure, a galvanized finish must be supplied, and/or adequate field painting is required for proper weather proofing.

ANY AND ALL IMPLIED WARRANTIES APPLICABLE HERETO ARE LIMITED TO ONE YEAR FROM THE DATE OF PURCHASE. Some states do not allow limitations on how long an implied warranty lasts, so the above time limitation may not apply to you.

In the event the original consumer purchaser of any Timely Industries Prefinished Steel Door Frame believes that the frame or any parts thereof covered by this warranty is defective, a letter outlining the alleged defect should be sent postage prepaid to the following address:

TIMELY INDUSTRIES, 10241 NORRIS AVE, PACOIMA, CA 91331

Any Timely Prefinished Steel Door Frame or any parts thereof covered by this warranty which, upon inspection by an authorized Representative of Timely Industries are found by said Representative to be defective, will at the option of Timely Industries either repair, replace or refund the purchase price of the frame or component part. Liability is limited to repair, replacement or refund and does not include labor, installation cost, or indirect or consequential damages of any nature. Some states do not allow the exclusion or limitation of incidental or consequential damages, so the above limitation or exclusion, set forth in this paragraph, may not apply to you.

This warranty gives you specific legal rights, and you may also have other rights which vary from state to state.

TECHNICAL SUPPORT

Timely is not only recognized as the originator of the prefinished drywall frame concept, but the firm is well known for its innovative ideas, products and applications. Timely provides the services of a tool and die shop, a knowledgeable sales force and stocking distributors to satisfy your needs on time and at competitive prices. We are committed to providing nothing less than the best.